

## Oscieznica + Ramiak Profil Standard

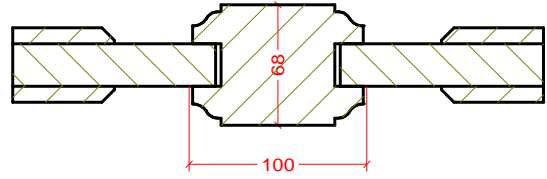
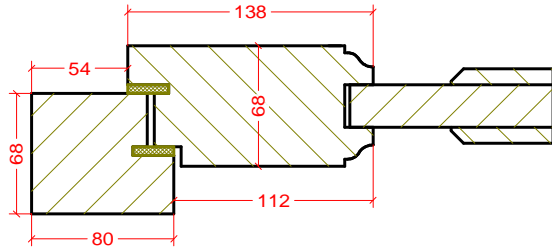
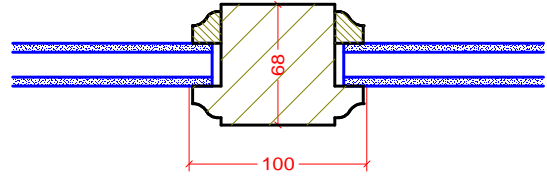
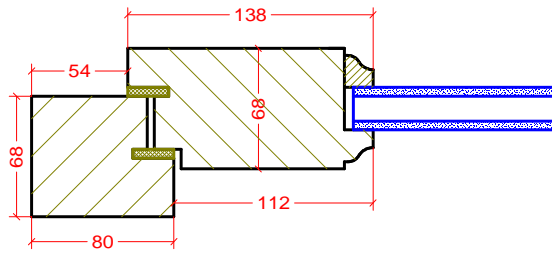

**BIK**

ul. Wedkarska 16  
66-470 Kostrzyn nad Odra  
tel: (095) 752 -37-77

[www.turen.pl](http://www.turen.pl)

bik@kostrzyn.com.pl

## Oscieznica + Ramiak Profil Retro

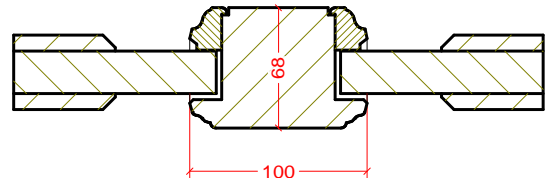
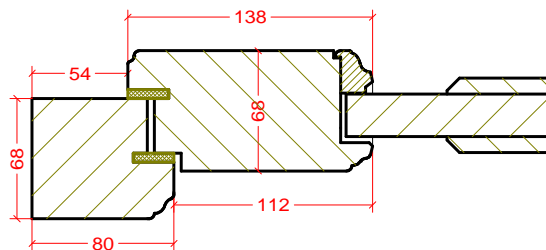
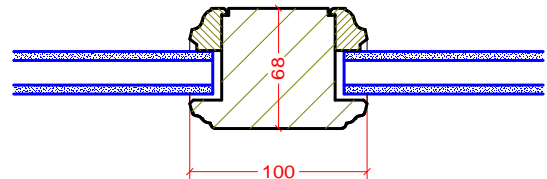
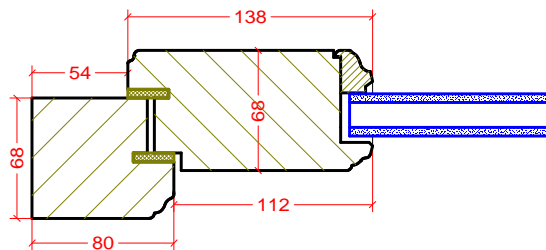

**BIK**

ul. Wedkarska 16  
66-470 Kostrzyn nad Odra  
tel: (095) 752 -37-77

[www.turen.pl](http://www.turen.pl)

bik@kostrzyn.com.pl

## Oscieznica + Ramiak Profil Retro Plus

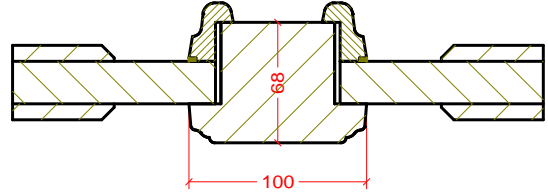
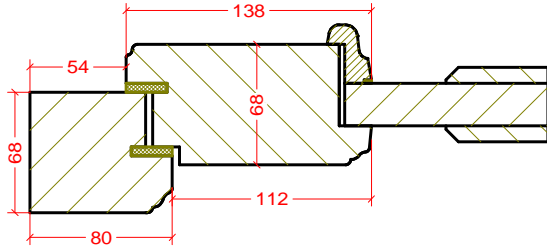
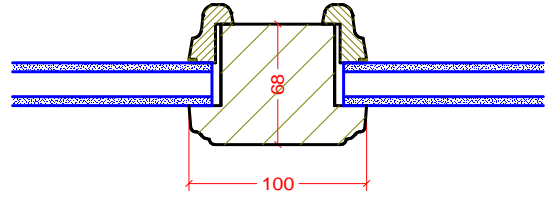
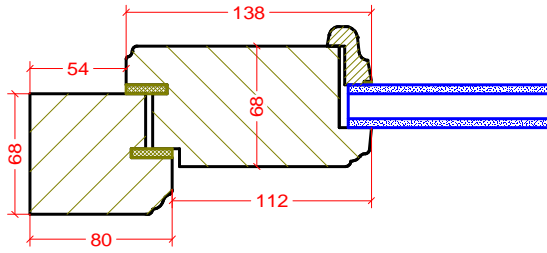

**BIK**

ul. Wedkarska 16  
66-470 Kostrzyn nad Odra  
tel: (095) 752 -37-77

[www.turen.pl](http://www.turen.pl)

bik@kostrzyn.com.pl

## Oscieznica + Ramiak Profil Klasyczny

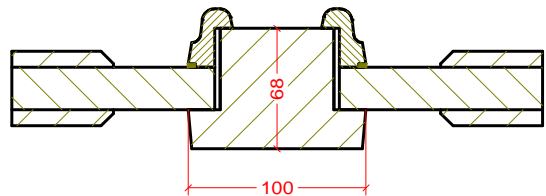
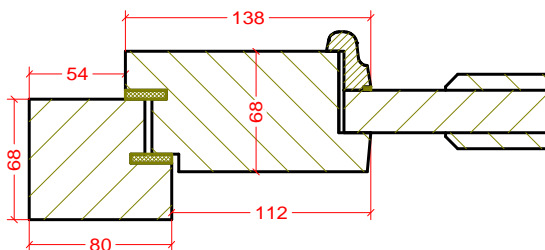
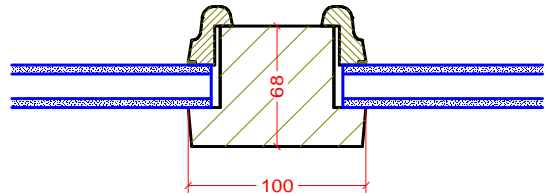
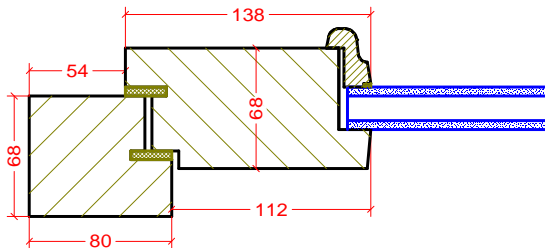

**BIK**

ul. Wedkarska 16  
66-470 Kostrzyn nad Odra  
tel: (095) 752 -37-77

[www.turen.pl](http://www.turen.pl)

bik@kostrzyn.com.pl

## Ramiak wewnętrzny drzwi dwuskrzydłowych

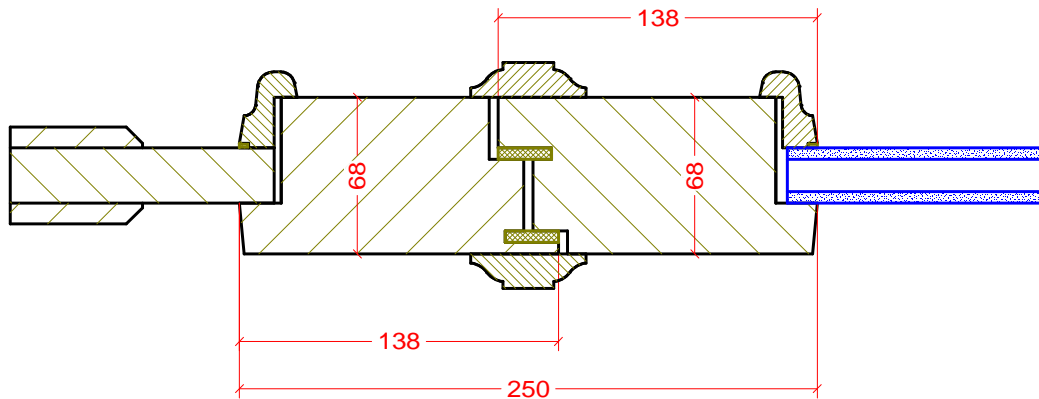
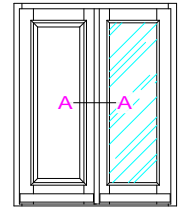

**BIK**

ul. Wedkarska 16  
66-470 Kostrzyn nad Odra  
tel: (095) 752 -37-77

[www.turen.pl](http://www.turen.pl)

bik@kostrzyn.com.pl

## Progi

*Próg dla drzwi  
otwieranych do wewnątrz*

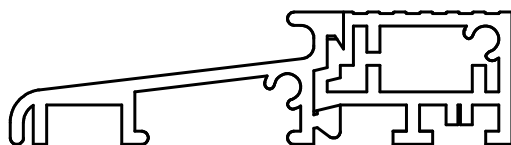

*Próg dla drzwi  
otwieranych na zewnątrz*

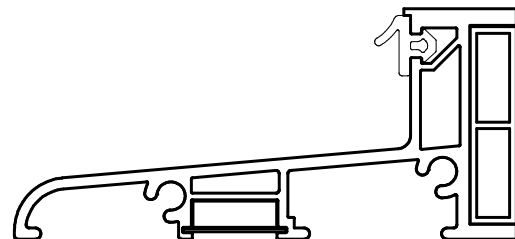

**BIK**

ul. Wedkarska 16  
66-470 Kostrzyn nad Odra  
tel: (095) 752 -37-77

[www.turen.pl](http://www.turen.pl)

bik@kostrzyn.com.pl

## Wzory Drzwi 1-4

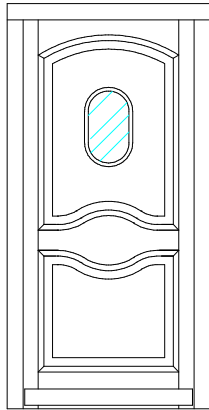

Wzór 1

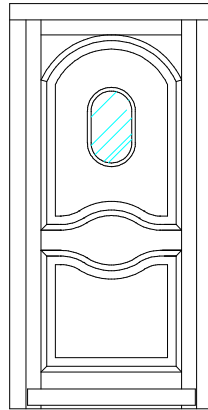

Wzór 2

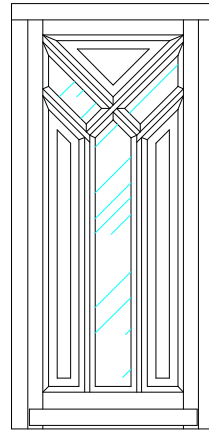

Wzór 3

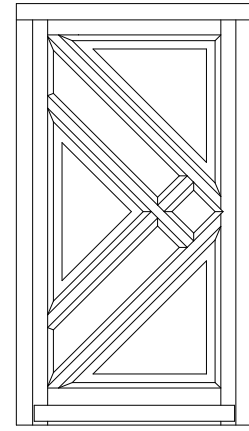

Wzór 4

**BIK**

ul. Wedkarska 16  
66-470 Kostrzyn nad Odra  
tel: (095) 752 -37-77

[www.turen.pl](http://www.turen.pl)

bik@kostrzyn.com.pl

## Wzory Drzwi 5-8

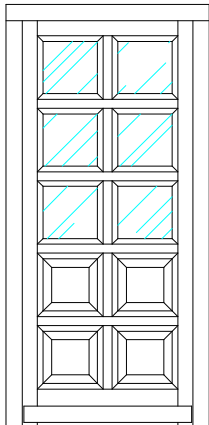

Wzór 5

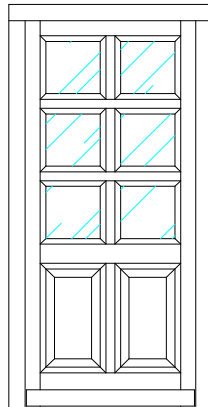

Wzór 6

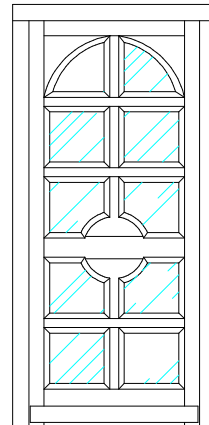

Wzór 7

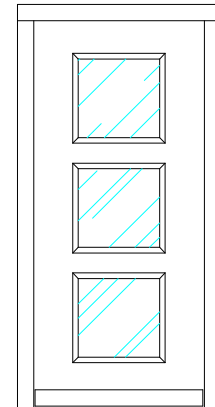

Wzór 8

**BIK**

ul. Wedkarska 16  
66-470 Kostrzyn nad Odra  
tel: (095) 752 -37-77

[www.turen.pl](http://www.turen.pl)

bik@kostrzyn.com.pl

## Wzory Drzwi 9-12

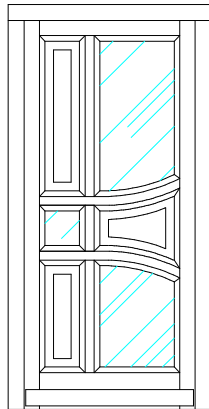

Wzór 9

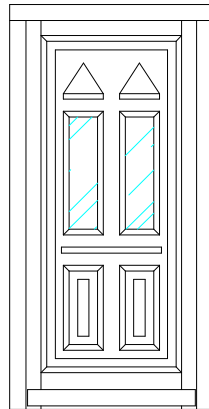

Wzór 10

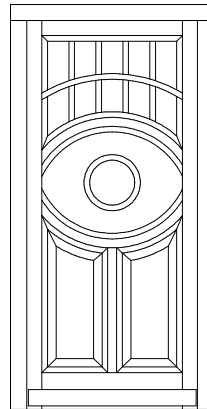

Wzór 11

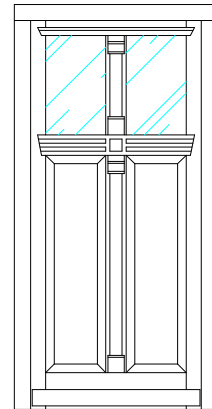

Wzór 12

**BIK**

ul. Wedkarska 16  
66-470 Kostrzyn nad Odra  
tel: (095) 752 -37-77

[www.turen.pl](http://www.turen.pl)

[bik@kostrzyn.com.pl](mailto:bik@kostrzyn.com.pl)

## Wzory Drzwi 13-16

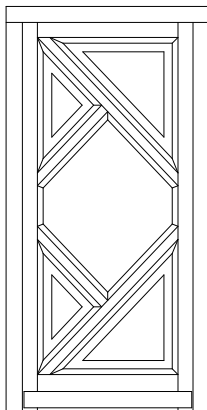

Wzór 13

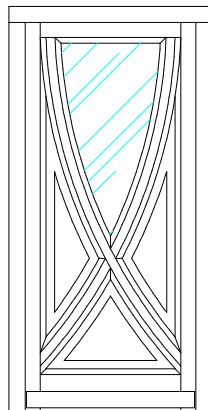

Wzór 14

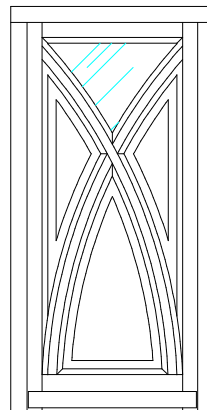

Wzór 15

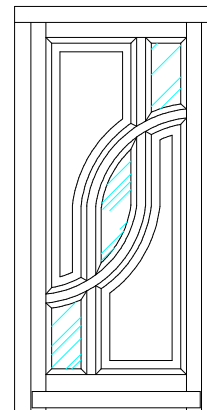

Wzór 16

**BIK**

ul. Wedkarska 16  
66-470 Kostrzyn nad Odra  
tel: (095) 752 -37-77

[www.turen.pl](http://www.turen.pl)

[bik@kostrzyn.com.pl](mailto:bik@kostrzyn.com.pl)

## Wzory Drzwi 17-20

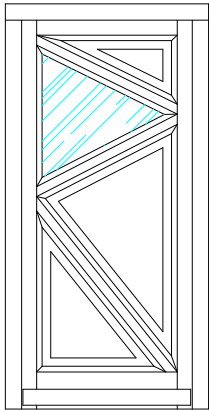

Wzór 17

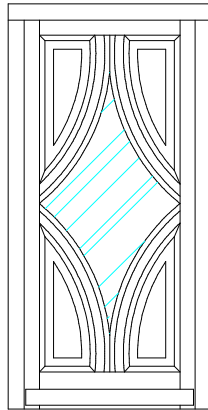

Wzór 18

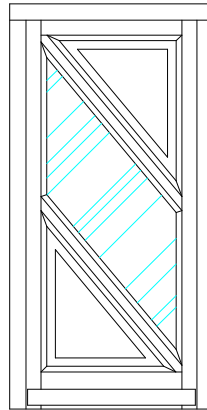

Wzór 19

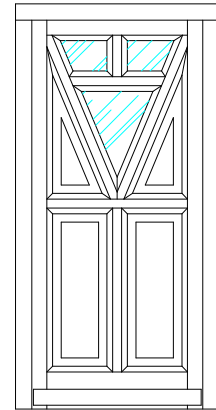

Wzór 20

**BIK**

ul. Wedkarska 16  
66-470 Kostrzyn nad Odra  
tel: (095) 752 -37-77

[www.turen.pl](http://www.turen.pl)

bik@kostrzyn.com.pl

## Wzory Drzwi 21-24

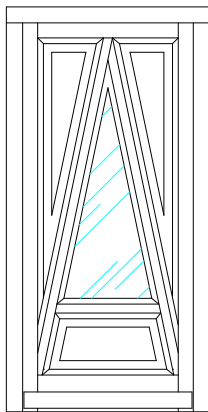

Wzór 21

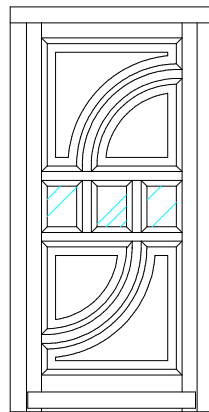

Wzór 22

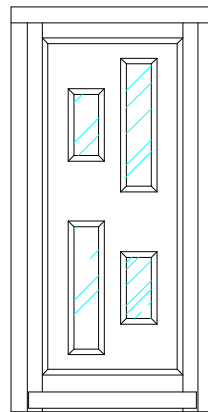

Wzór 23

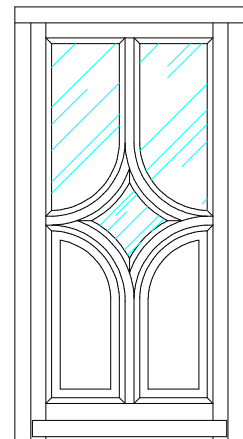

Wzór 24

**BIK**

ul. Wedkarska 16  
66-470 Kostrzyn nad Odra  
tel: (095) 752 -37-77

[www.turen.pl](http://www.turen.pl)

bik@kostrzyn.com.pl